

Ultra-Low Quiescent Current LDO Regulator

Features

- Ultra-Low 20 nA (typical) Quiescent Current
- Ultra-Low Shutdown Supply Current: 0.1 nA (typical)
- 200 mA Output Current Capability for $V_{OUT} < 3.5V$
- 100 mA Output Current Capability for $V_{OUT} > 3.5V$
- Input Operating Voltage Range: 2.7V to 5.5V
- Standard Output Voltages:
 - 1.2V, 1.8V, 2.5V, 3.3V, 4.2V
- Low-Dropout Voltage: 450 mV Maximum at 200 mA
- Stable with 1.0 μF Ceramic Output Capacitor
- Overcurrent Protection
- Space Saving, 8-Lead Plastic 2 x 2 VDFN-8

Applications

- Energy harvesting
- Long-life battery powered applications
- Smart cards
- Ultra-Low consumption "Green" products
- Portable electronics

Description

The MCP1710 is a 200 mA for $V_{OUT} < 3.5V$, 100 mA for $V_{OUT} > 3.5V$, low dropout (LDO) linear regulator that provides high-current and low-output voltages, while maintaining an ultra-low 20 nA of quiescent current during device operation. In addition, the MCP1710 can be shut down for an even lower 0.1 nA (typical) supply current draw. The MCP1710 comes in five standard fixed output voltage versions: 1.2V, 1.8V, 2.5V, 3.3V and 4.2V. The 200 mA output current capability, combined with the low output-voltage capability, make the MCP1710 a good choice for new ultra-long-life LDO applications that have high current demands, but require ultra-low power consumption during sleep states.

The MCP1710 is stable using ceramic output capacitors that inherently provide lower output noise and reduce the size and cost of the entire regulator solution. Only 1 μF (2.2 μF recommended) of output capacitance is needed to stabilize the LDO.

The MCP1710's ultra-low quiescent and shutdown current allows it to be paired with other ultra-low current draw devices, such as Microchip's nanoWatt XLP technology devices, for a complete ultra-low power solution.

Package Type

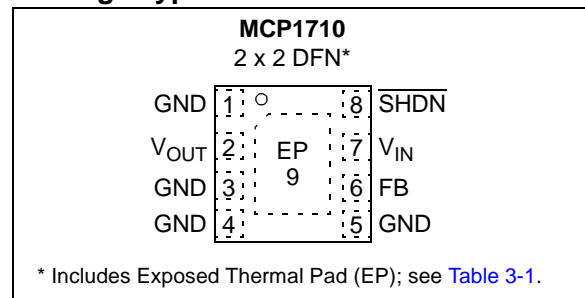

MCP1710

Typical Application

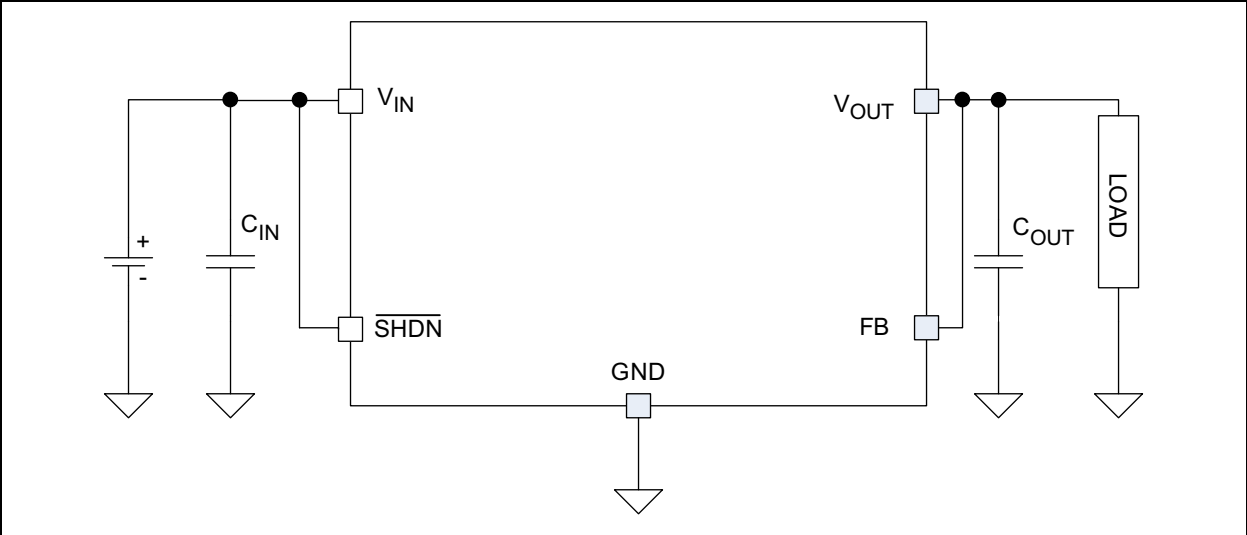

Functional Block Diagram

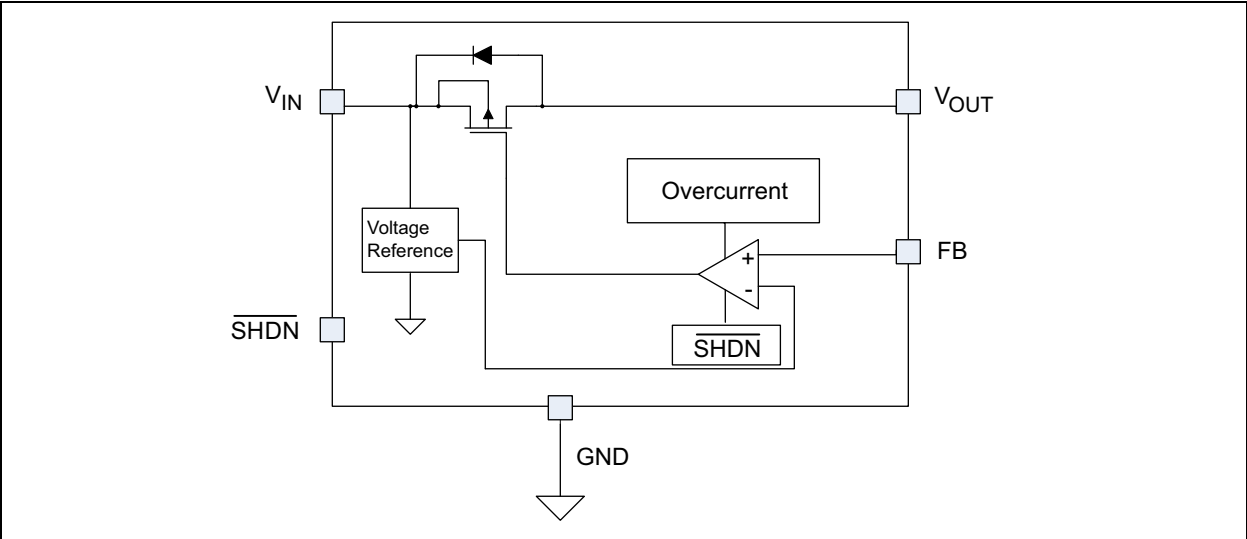

1.0 ELECTRICAL CHARACTERISTICS

Absolute Maximum Ratings †

Input Voltage, V_{IN}	6.0V
Maximum Voltage on Any Pin	(GND – 0.3V) to 6.0V
Output Short Circuit Duration.....	Unlimited
Storage temperature	-65°C to +150°C
Maximum Junction Temperature, T_J	+150°C
Operating Junction Temperature, T_J	-40°C to +85°C
ESD protection on all pins.....	≥ 2 kV HBM

† **Notice:** Stresses above those listed under “Maximum Ratings” may cause permanent damage to the device. This is a stress rating only and functional operation of the device at those or any other conditions above those indicated in the operational listings of this specification is not implied. Exposure to maximum rating conditions for extended periods may affect device reliability.

AC/DC CHARACTERISTICS

Electrical Specifications: Unless otherwise noted, $V_{IN} = V_R + 800\text{ mV}$, $V_{IN(\min)} = V_R + 0.3\text{V}$, $V_{IN(\max)} = 5.5\text{V}$, **Note 1**, $I_{OUT} = 1\text{ mA}$, $C_{IN} = C_{OUT} = 2.2\text{ }\mu\text{F}$ (X7R Ceramic), $T_A = +25^\circ\text{C}$. **Boldface** type applies for junction temperatures, T_J (**Note 4**) of **-40°C to +85°C**

Parameters	Sym	Min	Typ	Max	Units	Conditions
Input Operating Voltage	V_{IN}	2.7	—	5.5	V	
Output Voltage Range	V_{OUT}	1.2	—	4.2	V	
Input Quiescent Current	I_q	—	20	—	nA	$V_{IN} = V_R + 0.8\text{V}$ to 5.5V, $I_{OUT} = 0$
Input Quiescent Current for SHDN Mode	I_{SHDN}	—	0.1	—	nA	SHDN = GND
Maximum Continuous Output Current	I_{OUT}	200	—	—	mA	$V_{IN} = V_R + 0.8\text{V}$ to 5.5V $1.2\text{V} \leq V_R \leq 3.5\text{V}$
		100	—	—	mA	$V_{IN} = V_R + 0.8\text{V}$ to 5.5V $3.5\text{V} \leq V_R \leq 5.5\text{V}$
Current Limit	I_{OUT}	—	250	—	mA	$V_{OUT} = 0.9 \times V_R$ $1.2\text{V} \leq V_R \leq 3.5\text{V}$
		—	175	—	mA	$V_{OUT} = 0.9 \times V_R$ $3.5\text{V} \leq V_R \leq 5.5\text{V}$
Output Voltage Regulation	V_{OUT}	$V_R - 4\%$	—	$V_R + 4\%$	V	$V_R < 1.8\text{V}$ (Note 2)
		$V_R - 2\%$	—	$V_R + 4\%$	V	$1.8\text{V} < V_R < 5.5\text{V}$ (Note 2)
Line Regulation	$\frac{\Delta V_{OUT}}{(V_{OUT} \times \Delta V_{IN})}$	-2	0.5	2	%/V	(Note 1) $\leq V_{IN} \leq 5\text{V}$ $V_R < 1.8\text{V}$, $I_{OUT} = 50\text{ mA}$
		-1	—	1	%/V	(Note 1) $\leq V_{IN} \leq 5\text{V}$ $V_R = 1.8\text{V}$ to 4.2V $I_{OUT} = 50\text{ mA}$
Load Regulation	$\Delta V_{OUT}/V_{OUT}$	-2	1	2	%	V_{IN} = to 5.5V, $1.2\text{V} < V_R < 3.5\text{V}$ $I_{OUT} = 1\text{ mA}$ to 200 mA,
		-2	1	2	%	$3.5\text{V} < V_R < 5.5\text{V}$ $I_{OUT} = 1\text{ mA}$ to 100 mA,

- Note 1:** The minimum V_{IN} must meet two conditions: $V_{IN} \geq 2.7\text{V}$ and $V_{IN} \geq V_R + V_{DROPOUT(\text{MAX})}$.
- 2:** V_R is the nominal regulator output voltage. $V_R = 1.2\text{V}$, 2.5V , etc.
- 3:** Dropout voltage is defined as the input-to-output voltage differential at which the output voltage drops 3% below its nominal value that was measured with an input voltage of $V_{IN} = V_{OUT(\text{MAX})} + V_{DROPOUT(\text{MAX})}$.
- 4:** The junction temperature is approximated by soaking the device under test at an ambient temperature equal to the desired junction temperature. The test time is small enough such that the rise in the junction temperature over the ambient temperature is not significant.

MCP1710

AC/DC CHARACTERISTICS (CONTINUED)

Electrical Specifications: Unless otherwise noted, $V_{IN} = V_R + 800\text{ mV}$, $V_{IN(min)} = V_R + 0.3\text{V}$, $V_{IN(max)} = 5.5\text{V}$, **Note 1**, $I_{OUT} = 1\text{ mA}$, $C_{IN} = C_{OUT} = 2.2\text{ }\mu\text{F}$ (X7R Ceramic), $T_A = +25^\circ\text{C}$. **Boldface** type applies for junction temperatures, T_J (**Note 4**) of **-40°C to +85°C**

Parameters	Sym	Min	Typ	Max	Units	Conditions
Dropout Voltage	$V_{DROPOUT}$	—	—	450	mV	$I_{OUT} = 200\text{ mA}$ $1.2\text{V} \leq V_R \leq 3.5\text{V}$, Note 3
		—	—	400	mV	$I_{out} = 100\text{mA}$ $3.5\text{V} \leq V_R \leq 5.5\text{V}$, Note 3
Shutdown Input						
Logic High Input	$V_{SHDN-HIGH}$	70	—	—	% V_{IN}	$V_{IN} = 2.7\text{V}$ to 5.5V
Logic Low Input	$V_{SHDN-LOW}$	—	—	30	% V_{IN}	$V_{IN} = 2.7\text{V}$ to 5.5V
AC Performance						
Output Delay From $\overline{\text{SHDN}}$	T_{OR}	—	30	—	ms	$\overline{\text{SHDN}} = \text{GND}$ to V_{IN} , $V_{OUT} = \text{GND}$ to $95\% V_R$
Output Noise	e_N	—	0.37	—	$\mu\text{V}/\sqrt{\text{Hz}}$	$I_{OUT} = 50\text{ mA}$, $f = 1\text{ kHz}$, $C_{OUT} = 2.2\text{ }\mu\text{F}$ (X7R Ceramic) $V_{OUT} = 2.5\text{V}$
Power Supply Ripple Rejection Ratio	PSRR	—	22	—	dB	$f = 100\text{ Hz}$, $I_{OUT} = 10\text{ mA}$, $V_{INAC} = 200\text{ mV pk-pk}$, $C_{IN} = 0\text{ }\mu\text{F}$

- Note 1:** The minimum V_{IN} must meet two conditions: $V_{IN} \geq 2.7\text{V}$ and $V_{IN} \geq V_R + V_{DROPOUT(MAX)}$.
- 2:** V_R is the nominal regulator output voltage. $V_R = 1.2\text{V}$, 2.5V , etc.
- 3:** Dropout voltage is defined as the input-to-output voltage differential at which the output voltage drops 3% below its nominal value that was measured with an input voltage of $V_{IN} = V_{OUT(MAX)} + V_{DROPOUT(MAX)}$.
- 4:** The junction temperature is approximated by soaking the device under test at an ambient temperature equal to the desired junction temperature. The test time is small enough such that the rise in the junction temperature over the ambient temperature is not significant.

TEMPERATURE SPECIFICATIONS

Electrical Specifications: Unless otherwise noted, $V_{IN} = V_R + 800\text{ mV}$, $V_{IN(min)} = V_R + 0.3\text{V}$, $V_{IN(max)} = 5.5\text{V}$, **Note 1**, $I_{OUT} = 1\text{ mA}$, $C_{IN} = C_{OUT} = 2.2\text{ }\mu\text{F}$ (X7R Ceramic), $T_A = +25^\circ\text{C}$. **Boldface** type applies for junction temperatures, T_J (**Note 4**) of **-40°C to +85°C**

Parameters	Sym	Min	Typ	Max	Units	Conditions
Temperature Ranges						
Operating Junction Temperature Range	T_J	-40	—	+85	$^\circ\text{C}$	Steady State
Maximum Junction Temperature	T_J	—	—	+150	$^\circ\text{C}$	Transient
Storage Temperature Range	T_A	-65	—	+150	$^\circ\text{C}$	
Thermal Package Resistances						
Thermal Resistance, $2 \times 2\text{ VDFN-8}$	θ_{JA}	—	73.1	—	$^\circ\text{C}/\text{W}$	FR4 Board Only
	θ_{JC}	—	10.7	—	$^\circ\text{C}/\text{W}$	1 oz. Copper JEDEC Standard Board with Thermal Vias

2.0 TYPICAL PERFORMANCE CURVES

Note: The graphs and tables provided following this note are a statistical summary based on a limited number of samples and are provided for informational purposes only. The performance characteristics listed herein are not tested or guaranteed. In some graphs or tables, the data presented may be outside the specified operating range (e.g., outside specified power supply range) and therefore outside the warranted range.

Note: Unless otherwise indicated, $C_{OUT} = 2.2 \mu\text{F}$ Ceramic (X7R), $C_{IN} = 2.2 \mu\text{F}$ Ceramic (X7R), $I_{OUT} = 1 \text{ mA}$, Temperature = $+25^\circ\text{C}$, $V_{IN} = V_{OUT} + 0.8\text{V}$, $\overline{\text{SHDN}} = 1 \text{ M}\Omega$ pullup to V_{IN} .

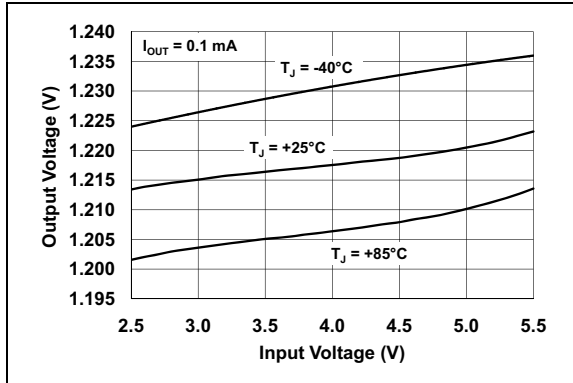

FIGURE 2-1: Output Voltage vs. Input Voltage ($V_R = 1.2\text{V}$).

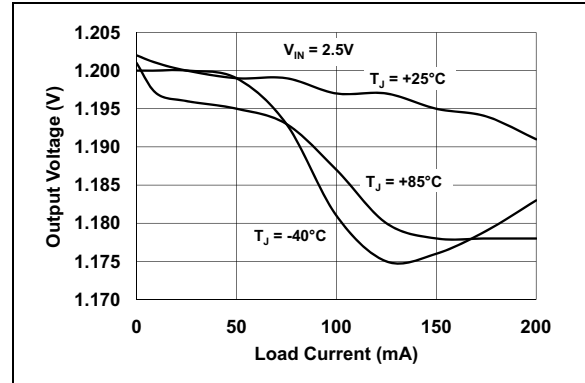

FIGURE 2-4: Output Voltage vs. Load Current ($V_R = 1.2\text{V}$).

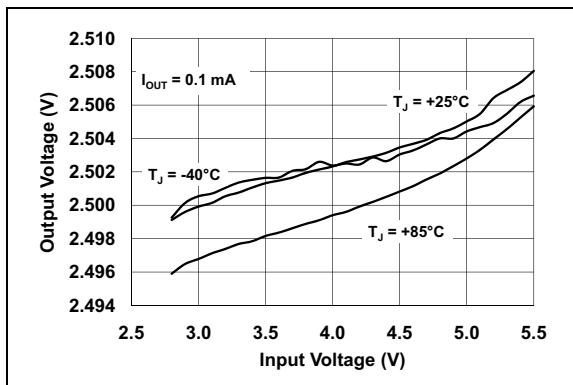

FIGURE 2-2: Output Voltage vs. Input Voltage ($V_R = 2.5\text{V}$).

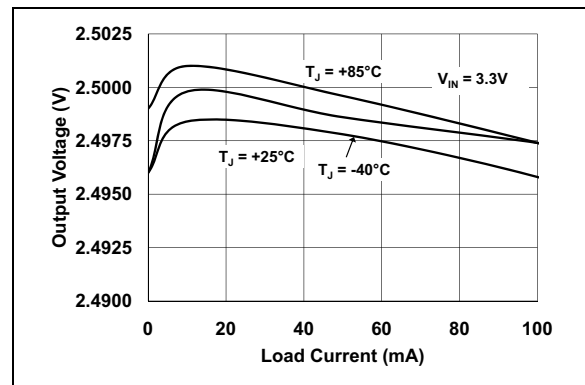

FIGURE 2-5: Output Voltage vs. Load Current ($V_R = 2.5\text{V}$).

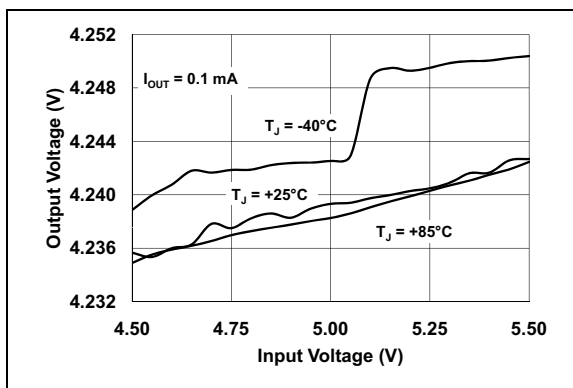

FIGURE 2-3: Output Voltage vs. Input Voltage ($V_R = 4.2\text{V}$).

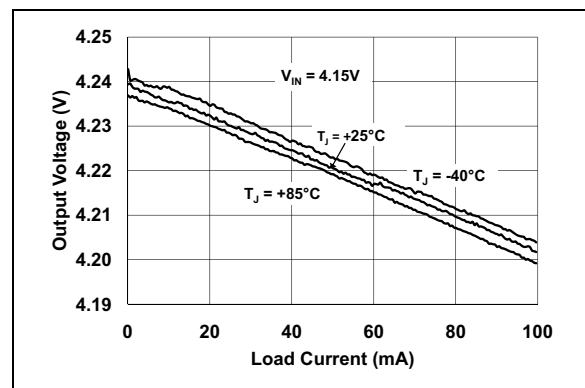

FIGURE 2-6: Output Voltage vs. Load Current ($V_R = 4.2\text{V}$).

MCP1710

Note: Unless otherwise indicated, $C_{OUT} = 2.2 \mu\text{F}$ Ceramic (X7R), $C_{IN} = 2.2 \mu\text{F}$ Ceramic (X7R), $I_{OUT} = 1 \text{ mA}$, Temperature = $+25^\circ\text{C}$, $V_{IN} = V_{OUT} + 0.8\text{V}$, $\text{SHDN} = 1 \text{ M}\Omega$ pullup to V_{IN} .

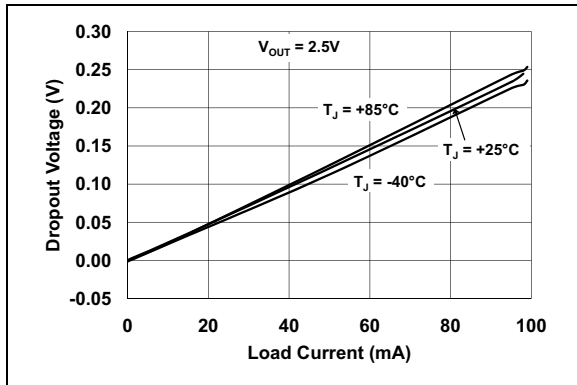

FIGURE 2-7: Dropout Voltage vs. Load Current ($V_R = 2.5\text{V}$).

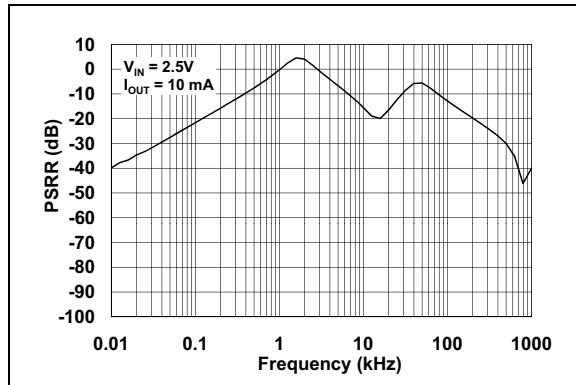

FIGURE 2-10: Power Supply Ripple Rejection vs. Frequency ($V_R = 1.2\text{V}$).

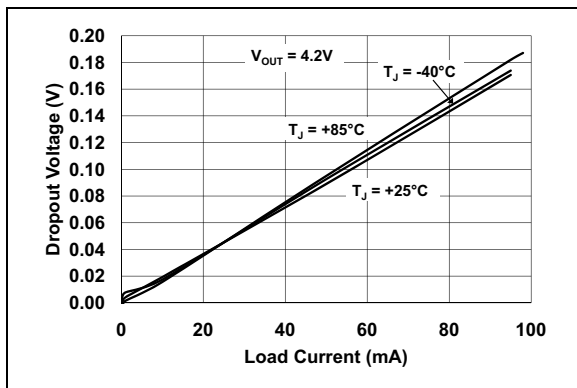

FIGURE 2-8: Dropout Voltage vs. Load Current ($V_R = 4.2\text{V}$).

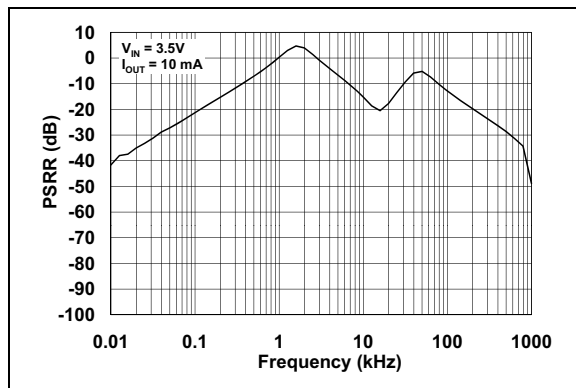

FIGURE 2-11: Power Supply Ripple Rejection vs. Frequency ($V_R = 2.5\text{V}$).

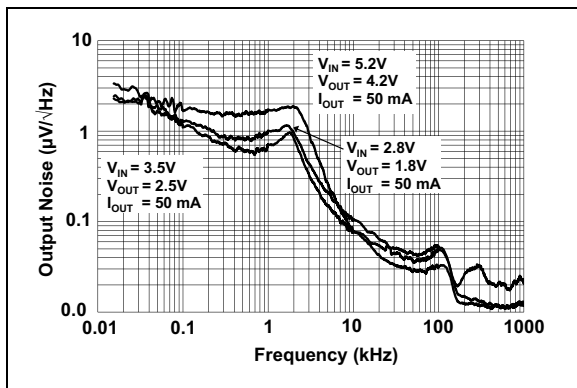

FIGURE 2-9: Noise vs. Frequency.

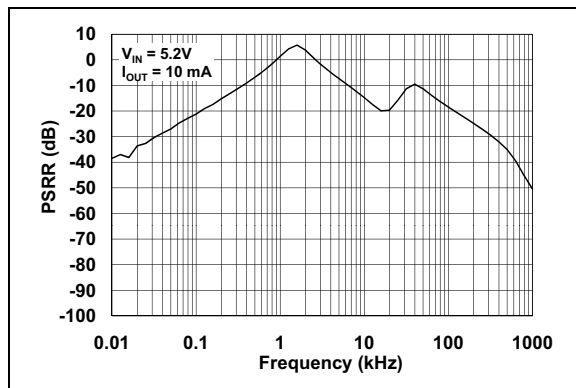

FIGURE 2-12: Power Supply Ripple Rejection vs. Frequency ($V_R = 4.2\text{V}$).

Note: Unless otherwise indicated, $C_{OUT} = 2.2 \mu\text{F}$ Ceramic (X7R), $C_{IN} = 2.2 \mu\text{F}$ Ceramic (X7R), $I_{OUT} = 1 \text{ mA}$, Temperature = $+25^\circ\text{C}$, $V_{IN} = V_{OUT} + 0.8\text{V}$, $\text{SHDN} = 1 \text{ M}\Omega$ pullup to V_{IN} .

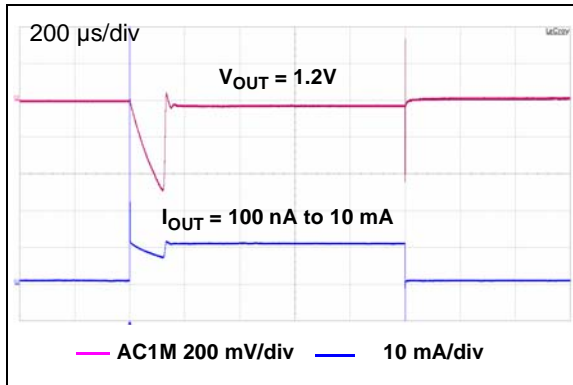

FIGURE 2-13: Dynamic Load Step ($V_R = 1.2\text{V}$).

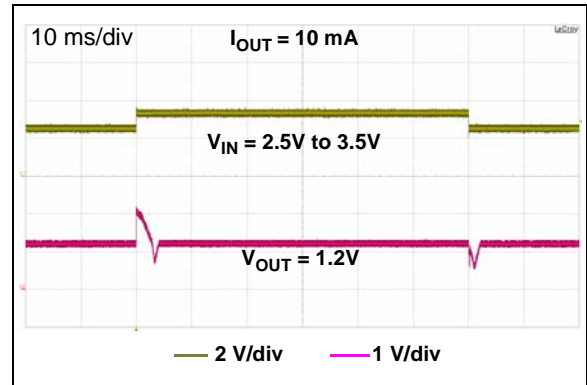

FIGURE 2-16: Dynamic Line Step ($V_R = 1.2\text{V}$).

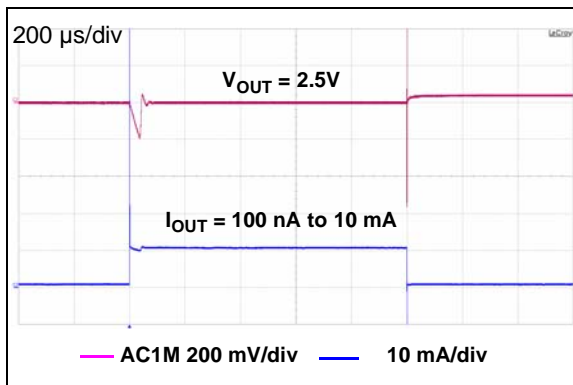

FIGURE 2-14: Dynamic Load Step ($V_R = 2.5\text{V}$).

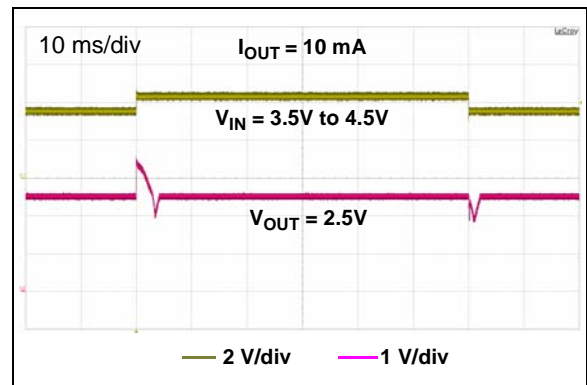

FIGURE 2-17: Dynamic Line Step ($V_R = 2.5\text{V}$).

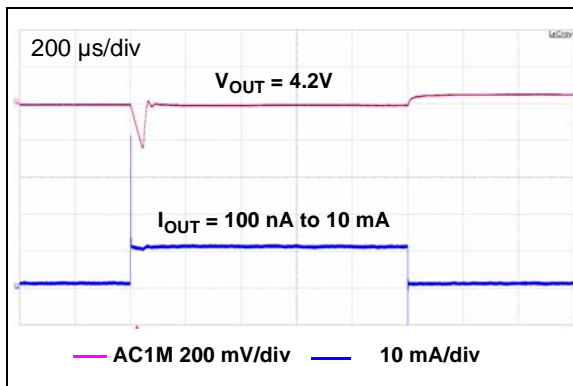

FIGURE 2-15: Dynamic Load Step ($V_R = 4.2\text{V}$).

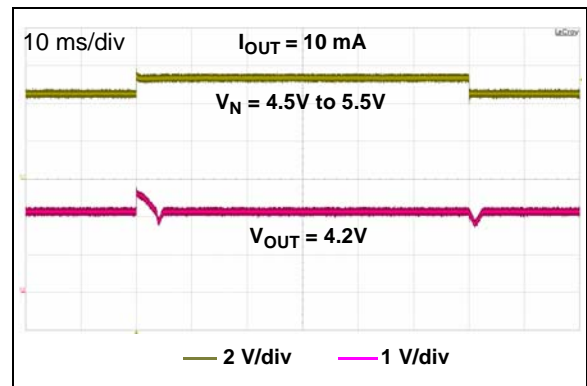

FIGURE 2-18: Dynamic Line Step ($V_R = 4.2\text{V}$).

MCP1710

Note: Unless otherwise indicated, $C_{OUT} = 2.2 \mu\text{F}$ Ceramic (X7R), $C_{IN} = 2.2 \mu\text{F}$ Ceramic (X7R), $I_{OUT} = 1 \text{ mA}$, Temperature = $+25^\circ\text{C}$, $V_{IN} = V_{OUT} + 0.8\text{V}$, $\overline{\text{SHDN}} = 1 \text{ M}\Omega$ pullup to V_{IN} .

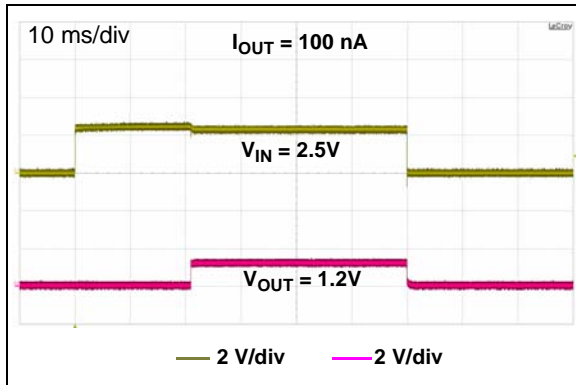

FIGURE 2-19: Startup From V_{IN} ($V_R = 1.2\text{V}$).

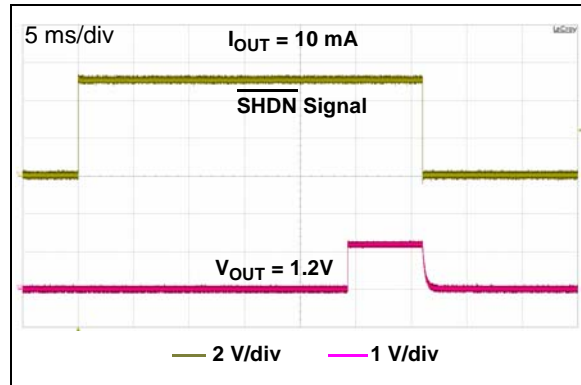

FIGURE 2-22: Startup From $\overline{\text{SHDN}}$ ($V_R = 1.2\text{V}$).

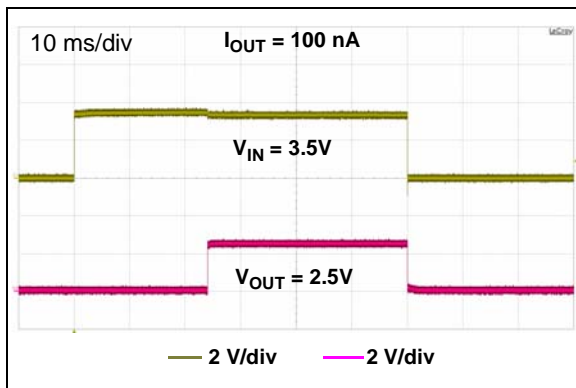

FIGURE 2-20: Startup From V_{IN} ($V_R = 2.5\text{V}$).

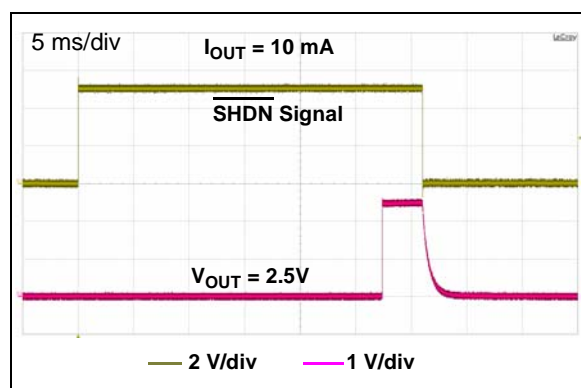

FIGURE 2-23: Startup From $\overline{\text{SHDN}}$ ($V_R = 2.5\text{V}$).

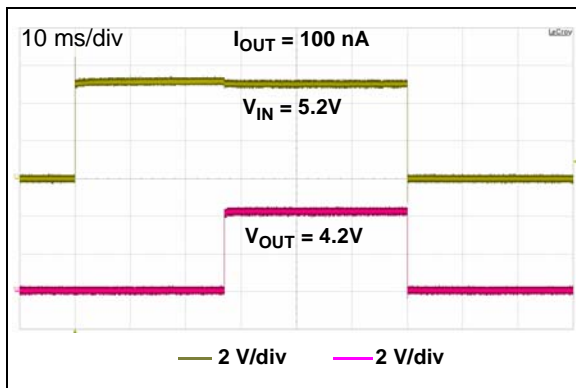

FIGURE 2-21: Startup From V_{IN} ($V_R = 4.2\text{V}$).

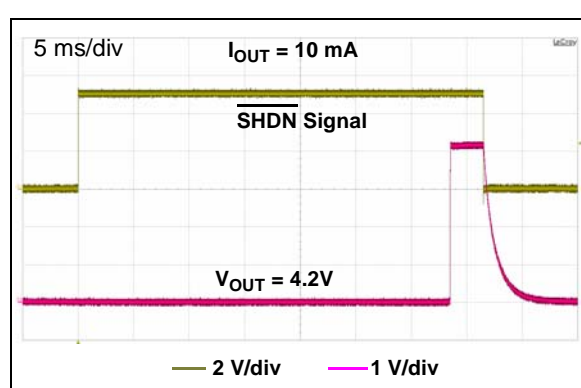

FIGURE 2-24: Startup From $\overline{\text{SHDN}}$ ($V_R = 4.2\text{V}$).

Note: Unless otherwise indicated, $C_{OUT} = 2.2 \mu\text{F}$ Ceramic (X7R), $C_{IN} = 2.2 \mu\text{F}$ Ceramic (X7R), $I_{OUT} = 1 \text{ mA}$, Temperature = $+25^\circ\text{C}$, $V_{IN} = V_{OUT} + 0.8\text{V}$, $\overline{\text{SHDN}} = 1 \text{ M}\Omega$ pullup to V_{IN} .

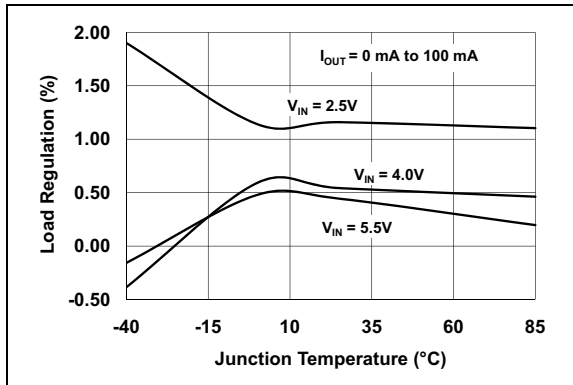

FIGURE 2-25: Load Regulation vs. Junction Temperature ($V_R = 1.2\text{V}$).

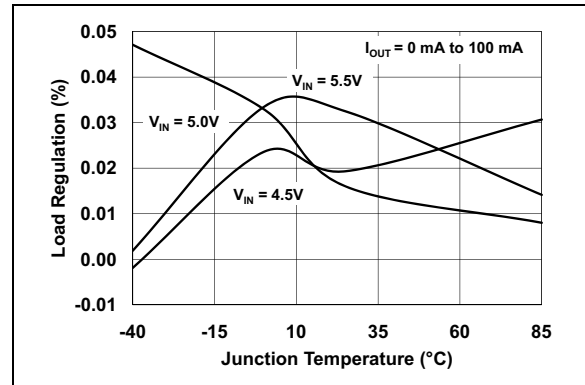

FIGURE 2-27: Load Regulation vs. Junction Temperature ($V_R = 4.2\text{V}$).

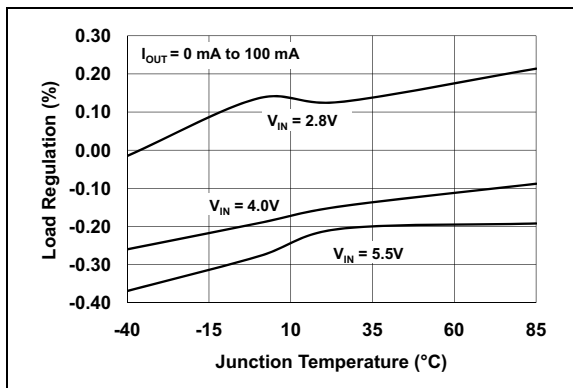

FIGURE 2-26: Load Regulation vs. Junction Temperature ($V_R = 2.5\text{V}$).

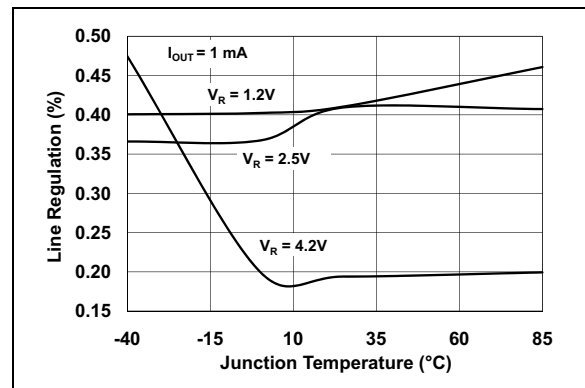

FIGURE 2-28: Line Regulation vs. Junction Temperature.

MCP1710

Note: Unless otherwise indicated, $C_{OUT} = 2.2 \mu\text{F}$ Ceramic (X7R), $C_{IN} = 2.2 \mu\text{F}$ Ceramic (X7R), $I_{OUT} = 1 \text{ mA}$, Temperature = $+25^\circ\text{C}$, $V_{IN} = V_{OUT} + 0.8\text{V}$, $\overline{\text{SHDN}} = 1 \text{ M}\Omega$ pullup to V_{IN} .

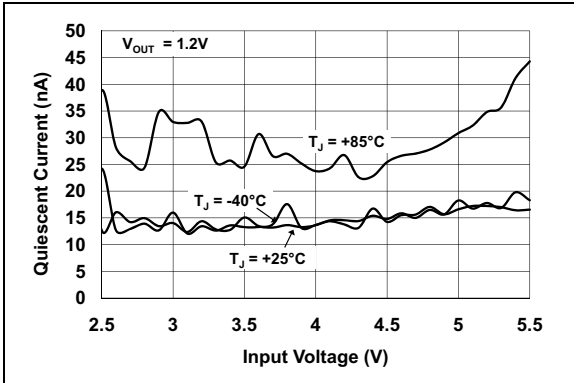

FIGURE 2-29: Quiescent Current vs. Input Voltage.

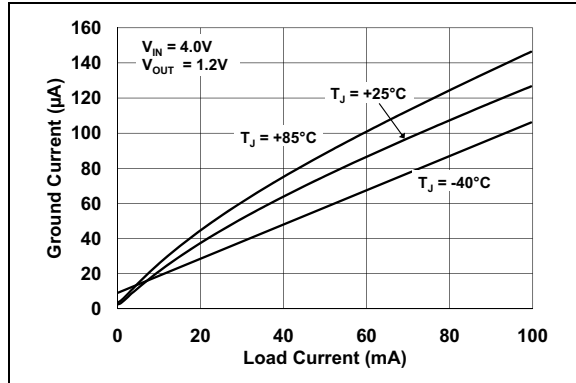

FIGURE 2-31: Ground Current vs. Load Current.

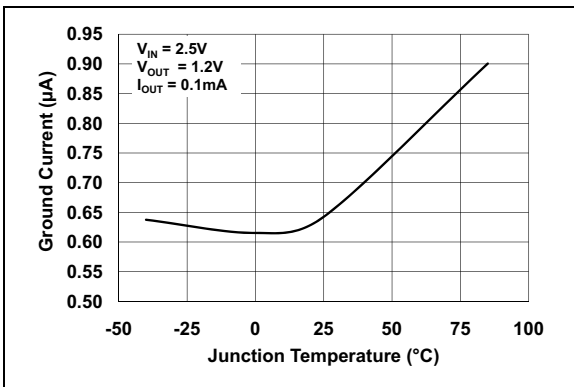

FIGURE 2-30: Ground Current vs. Junction Temperature.

3.0 PIN DESCRIPTION

The descriptions of the pins are listed in [Table 3-1](#).

TABLE 3-1: PIN FUNCTION TABLE

MCP1710 VDFN	Name	Description
1, 3, 4, 5,	GND	Ground
2	V _{OUT}	Regulated Output Voltage
6	FB	Output Voltage Feedback Input
7	V _{IN}	Input Voltage Supply
8	$\overline{\text{SHDN}}$	Shutdown Control Input (active-low)
9	EP	Exposed Pad, connected to GND.

3.1 Ground Pin (GND)

For optimal Noise and Power Supply Rejection Ratio (PSRR) performance, the GND pin of the LDO should be tied to an electrically quiet circuit ground. This will help the LDO power supply rejection ratio and noise performance. The ground pin of the LDO only conducts the ground current, so a heavy trace is not required. For applications that have switching or noisy inputs, tie the GND pin to the return of the output capacitor. Ground planes help lower the inductance and voltage spikes caused by fast transient load currents.

3.2 Regulated Output Voltage Pin (V_{OUT})

The V_{OUT} pin is the regulated output voltage of the LDO. A minimum output capacitance of 1.0 μF is required for LDO stability. The MCP1710 is stable with ceramic, tantalum and aluminum-electrolytic capacitors. See [Section 4.2 “Output Capacitor”](#) for output capacitor selection guidance.

3.3 Feedback Pin (FB)

The output voltage is connected to the FB input. This sets the output voltage regulation value.

3.4 Input Voltage Supply Pin (V_{IN})

Connect the unregulated or regulated input voltage source to V_{IN}. If the input voltage source is located several inches away from the LDO, or the input source is a battery, it is recommended that an input capacitor be used. A typical input capacitance value of 1 μF to 10 μF should be sufficient for most applications (2.2 μF , typical). The type of capacitor used can be ceramic, tantalum, or aluminum electrolytic. The low ESR characteristics of the ceramic capacitor will yield better noise and PSRR performance at high frequency.

3.5 Shutdown Control Input ($\overline{\text{SHDN}}$)

The $\overline{\text{SHDN}}$ input is used to turn the LDO output voltage on and off. When the $\overline{\text{SHDN}}$ input is at a logic-high level, the LDO output voltage is enabled. When the $\overline{\text{SHDN}}$ input is pulled to a logic-low level, the LDO output voltage is disabled. When the $\overline{\text{SHDN}}$ input is pulled low, the LDO enters a low-quiescent current shutdown state, where the typical quiescent current is 0.1 nA.

3.6 Exposed Pad Pin (EP)

The VDFN-8 package has an exposed metal pad on the bottom of the package. The exposed metal pad gives the device better thermal characteristics by providing a good thermal path to either the PCB or heat sink, to remove heat from the device. The exposed pad of the package is at ground potential.

MCP1710

NOTES:

4.0 DEVICE OVERVIEW

The MCP1710 is a 100 mA/200 mA output current, low dropout (LDO) voltage regulator. The low dropout voltage of 450 mV maximum at 200 mA of current makes it ideal for battery-powered applications. The input voltage range is 2.7V to 5.5V. The MCP1710 adds a shutdown-control input pin. The MCP1710 is available in five standard fixed-output voltage options: 1.2V, 1.8V, 2.5V, 3.3V and 4.2V. The MCP1710 uses a proprietary voltage reference and sensing scheme to maintain the ultra-low 20 nA quiescent current.

4.1 Output Current and Current Limiting

The MCP1710 LDO is tested and ensured to supply a minimum of 200 mA of output current for the 1.2V to 3.5V output range, and 100 mA of output current for the 3.5V to 4.2V output range. The MCP1710 has no minimum output load, so the output load current can go to 0 mA and the LDO will continue to regulate the output voltage within the specified tolerance.

The MCP1710 also incorporates an output current limit. The current limit is set to 250 mA typical for the $1.2V \leq V_R \leq 3.5V$ range, and 175 mA typical for the $3.5V \leq V_R \leq 5.5V$ range.

4.2 Output Capacitor

The MCP1710 requires a minimum output capacitance of 1 μF for output voltage stability. Ceramic capacitors are recommended because of their size, cost and robust environmental qualities.

Aluminum-electrolytic and tantalum capacitors can be used on the LDO output as well. The output capacitor should be located as close to the LDO output as is practical. Ceramic materials X7R and X5R have low temperature coefficients and are well within the acceptable ESR range required. A typical 1 μF X7R 0805 capacitor has an ESR of 50 m Ω .

4.3 Input Capacitor

Low input-source impedance is necessary for the LDO output to operate properly. When operating from batteries, or in applications with long lead length (> 10 inches) between the input source and the LDO, some input capacitance is recommended. A minimum of 1.0 μF to 4.7 μF is recommended for most applications.

For applications that have output step load requirements, the input capacitance of the LDO is very important. The input capacitance provides the LDO with a good local low-impedance source to pull the transient currents from. This will allow the LDO to respond quickly to the output load step. For good step-response performance, the input capacitor should be of equivalent or higher value than the output capacitor. The capacitor should be placed as close to the input of the LDO as is practical. Larger input capacitors will also help reduce any high-frequency noise on the input and output of the LDO, and reduce the effects of any inductance that exists between the input source voltage and the input capacitance of the LDO.

4.4 Shutdown Input ($\overline{\text{SHDN}}$)

The $\overline{\text{SHDN}}$ input is an active-low input signal that turns the LDO on and off. The $\overline{\text{SHDN}}$ threshold is a percentage of the input voltage. The maximum input-low logic level is 30% of V_{IN} and the minimum high logic level is 70% of V_{IN} .

On the rising edge of the $\overline{\text{SHDN}}$ input, the shutdown circuitry has a 30 ms (typical) delay before allowing the LDO output to turn on. This delay helps to reject any false turn-on signal or noise on the $\overline{\text{SHDN}}$ input signal. After the 30 ms delay, the LDO output enters its current limited soft-start period as it rises from 0V to its final regulation value. If the $\overline{\text{SHDN}}$ input signal is pulled low during the 30 ms delay period, the timer will be reset and the delay time will start over again on the next rising edge of the $\overline{\text{SHDN}}$ input. The total time from the $\overline{\text{SHDN}}$ input going high (turn-on) to the LDO output being in regulation is typically 30 ms. See Figure 4-1 for a timing diagram of the $\overline{\text{SHDN}}$ input.

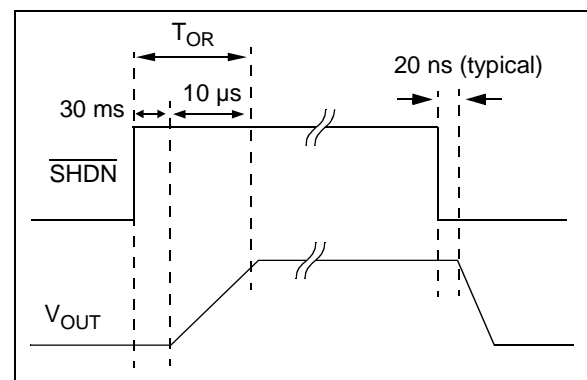

FIGURE 4-1: Shutdown Input Timing Diagram.

MCP1710

4.5 Dropout Voltage

Dropout voltage is defined as the input-to-output voltage differential at which the output voltage drops 3% below the nominal value that was measured with a $V_R + 0.8V$ differential applied. The MCP1710 LDO has a low-dropout voltage specification of 450 mV for the $1.2V \leq V_R \leq 3.5V$ range (typical) at 200 mA out, and 400mV for the $3.5V \leq V_R \leq 5.5V$ range (typical) at 100 mA out. See [Section 1.0 “Electrical Characteristics”](#) for maximum dropout voltage specifications.

5.0 APPLICATION CIRCUITS/ISSUES

5.1 Typical Application

The MCP1710 is used for applications that require ultra-low quiescent current draw.

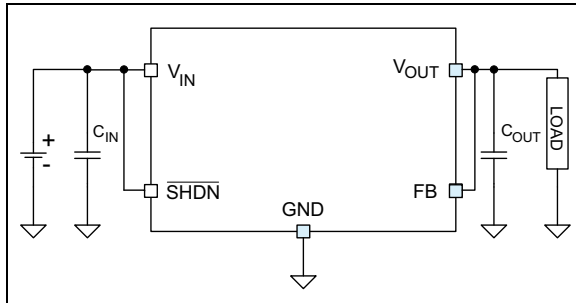

FIGURE 5-1: Typical Application Circuit.

5.2 Power Calculations

5.2.1 POWER DISSIPATION

The internal power dissipation within the MCP1710 is a function of input voltage, output voltage, output current and quiescent current. Equation 5-1 can be used to calculate the internal power dissipation for the LDO.

EQUATION 5-1:

$$P_{LDO} = (V_{IN(MAX)} - V_{OUT(MIN)}) \times I_{OUT(MAX)}$$

Where:

P_{LDO} = LDO Pass device internal power dissipation

$V_{IN(MAX)}$ = Maximum input voltage

$V_{OUT(MIN)}$ = LDO minimum output voltage

$I_{OUT(MAX)}$ = Maximum output current

In addition to the LDO pass element power dissipation, there is power dissipation within the MCP1710 as a result of quiescent or ground current. The power dissipation as a result of the ground current can be calculated using Equation 5-2:

EQUATION 5-2:

$$P_{I(GND)} = V_{IN(MAX)} \times I_{GND}$$

Where:

$P_{I(GND)}$ = Power dissipation due to the quiescent current of the LDO

$V_{IN(MAX)}$ = Maximum input voltage

I_{GND} = Current flowing in the GND pin

The total power dissipated within the MCP1710 is the sum of the power dissipated in the LDO pass device and the $P_{I(GND)}$ term. Because of the CMOS construction, the typical I_{GND} for the MCP1710 is 200 μ A at full load. Operating at a maximum V_{IN} of 5.5V results in a power dissipation of 1.1 mW. For most applications, this is small compared to the LDO pass device power dissipation, and can be neglected.

The maximum continuous operating junction temperature specified for the MCP1710 is +85°C. To estimate the internal junction temperature of the MCP1710, the total internal power dissipation is multiplied by the thermal resistance from junction-to-ambient ($R\theta_{JA}$) of the device. The thermal resistance from junction-to-ambient for the 2 x 2 VDFN-8 package is estimated at 73.1°C/W.

EQUATION 5-3:

$$T_{J(MAX)} = P_{TOTAL} \times R\theta_{JA} + T_{A(MAX)}$$

Where:

$T_{J(MAX)}$ = Maximum continuous junction temperature

P_{TOTAL} = Total device power dissipation

$R\theta_{JA}$ = Thermal resistance from junction to ambient

T_{AMAX} = Maximum ambient temperature

The maximum power dissipation capability for a package can be calculated given the junction-to-ambient thermal resistance and the maximum ambient temperature for the application. Equation 5-4 can be used to determine the package maximum internal power dissipation.

EQUATION 5-4:

$$P_{D(MAX)} = \frac{(T_{J(MAX)} - T_{A(MAX)})}{R\theta_{JA}}$$

Where:

$P_{D(MAX)}$ = Maximum device power dissipation

$T_{J(MAX)}$ = Maximum continuous junction temperature

$T_{A(MAX)}$ = Maximum ambient temperature

$R\theta_{JA}$ = Thermal resistance from junction-to-ambient

MCP1710

EQUATION 5-5:

$$T_{J(RISE)} = P_{D(MAX)} \times R\theta_{JA}$$

$T_{J(RISE)}$ = Rise in device junction temperature over the ambient temperature

$P_{D(MAX)}$ = Maximum device power dissipation

$R\theta_{JA}$ = Thermal resistance from junction-to-ambient

EQUATION 5-6:

$$T_J = T_{J(RISE)} + T_A$$

T_J = Junction temperature

$T_{J(RISE)}$ = Rise in device junction temperature over the ambient temperature

T_A = Ambient temperature

5.3 Typical Application Examples

Internal power dissipation, junction temperature rise, junction temperature and maximum power dissipation are calculated in the following example. The power dissipation as a result of ground current is small enough to be neglected.

5.3.1 POWER DISSIPATION EXAMPLE

EXAMPLE 5-1:

Package

Package Type = 2 x 2 VDFN-8

Input Voltage

$$V_{IN} = 3.3V \pm 5\%$$

LDO Output Voltage and Current

$$V_{OUT} = 2.5V$$

$$I_{OUT} = 200 \text{ mA}$$

Maximum Ambient Temperature

$$T_{A(MAX)} = +60^\circ\text{C}$$

Internal Power Dissipation

$$P_{LDO(MAX)} = (V_{IN(MAX)} - V_{OUT(MIN)}) \times I_{OUT(MAX)}$$

$$P_{LDO} = ((3.3V \times 1.05) - (2.5V \times 0.975)) \times 200 \text{ mA}$$

$$P_{LDO} = 0.206 \text{ Watts}$$

5.3.1.1 Device Junction Temperature Rise

The internal junction temperature rise is a function of internal power dissipation and the thermal resistance from junction-to-ambient for the application. The thermal resistance from junction-to-ambient ($R\theta_{JA}$) is derived from EIA/JEDEC standards for measuring thermal resistance. The EIA/JEDEC specification is JESD51. The standard describes the test method and board specifications for measuring the thermal resistance from junction-to-ambient. The actual thermal resistance for a particular application can vary depending on many factors such as copper area and thickness. Refer to AN792, "A Method to Determine How Much Power a SOT-23 Can Dissipate in an Application" (DS00792), for more information regarding this subject.

EXAMPLE 5-2:

$$T_{J(RISE)} = P_{TOTAL} \times R\theta_{JA}$$

$$T_{JRISE} = 0.206W \times 73.1^\circ\text{C/W}$$

$$T_{JRISE} = 15.1^\circ\text{C}$$

5.3.1.2 Junction Temperature Estimate

To estimate the internal junction temperature, the calculated temperature rise is added to the ambient or offset temperature. For this example, the worst-case junction temperature is estimated below:

EXAMPLE 5-3:

$$T_J = T_{JRISE} + T_{A(MAX)}$$

$$T_J = 15.1^\circ\text{C} + 60.0^\circ\text{C}$$

$$T_J = 75.1^\circ\text{C}$$

5.3.1.3 Maximum Package Power Dissipation at +60°C Ambient Temperature

EXAMPLE 5-4:

2x2 DFN-8 (73.1°C/W $R\theta_{JA}$):

$$P_{D(MAX)} = (85^\circ\text{C} - 60^\circ\text{C})/73.1^\circ\text{C/W}$$

$$P_{D(MAX)} = 0.342W$$

6.0 PACKAGING INFORMATION

6.1 Package Marking Information

8-Lead VDFN (2 x 2 x 0.9)

Example:

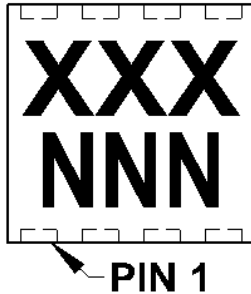

Part Number	Code
MCP1710T-12I/LZ	AAA
MCP1710T-18I/LZ	AAB
MCP1710T-25I/LZ	AAC
MCP1710T-33I/LZ	AAD
MCP1710T-42I/LZ	AAE

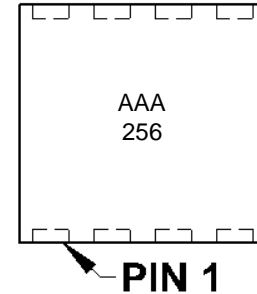

Legend:	XX...X	Customer-specific information
	Y	Year code (last digit of calendar year)
	YY	Year code (last 2 digits of calendar year)
	WW	Week code (week of January 1 is week '01')
	NNN	Alphanumeric traceability code
	(e3)	Pb-free JEDEC designator for Matte Tin (Sn)
	*	This package is Pb-free. The Pb-free JEDEC designator (e3) can be found on the outer packaging for this package.
Note:	In the event the full Microchip part number cannot be marked on one line, it will be carried over to the next line, thus limiting the number of available characters for customer-specific information.	

MCP1710

8-Lead Very Thin Dual Flatpack No-Lead (LZ) – 2x2x0.9 mm Body [VDFN]

Note: For the most current package drawings, please see the Microchip Packaging Specification located at <http://www.microchip.com/packaging>

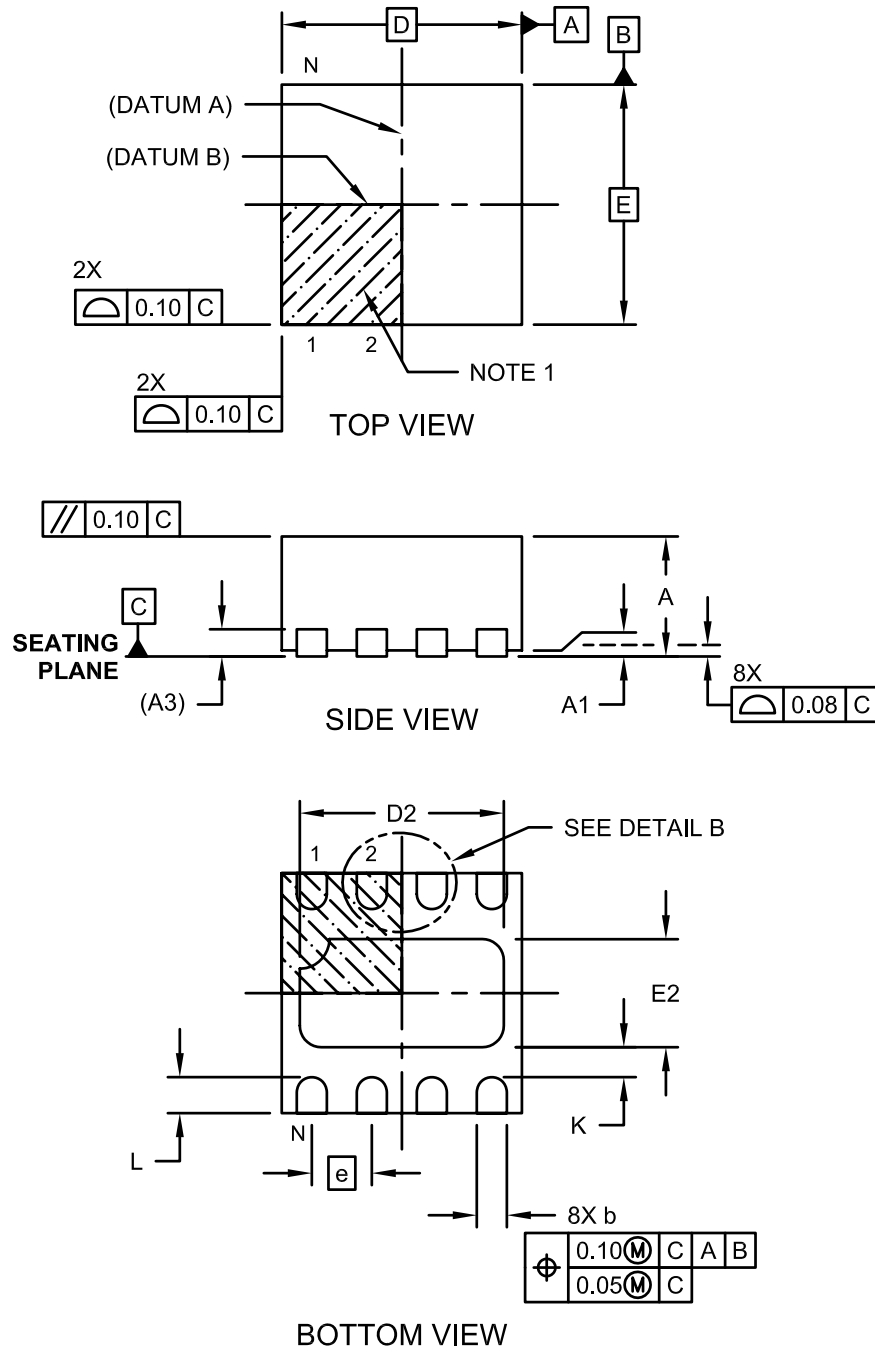

Microchip Technology Drawing C04-198A Sheet 1 of 2

8-Lead Very Thin Dual Flatpack No-Lead (LZ) – 2x2x0.9 mm Body [VDFN]

Note: For the most current package drawings, please see the Microchip Packaging Specification located at <http://www.microchip.com/packaging>

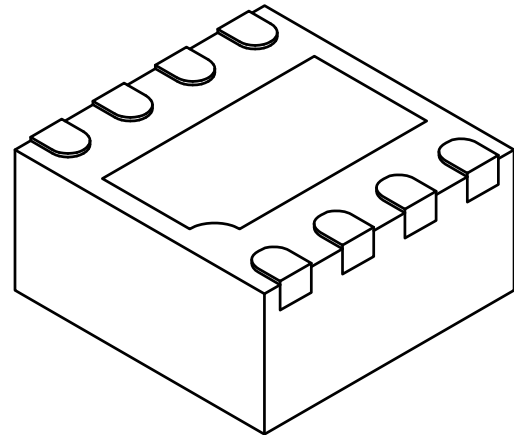
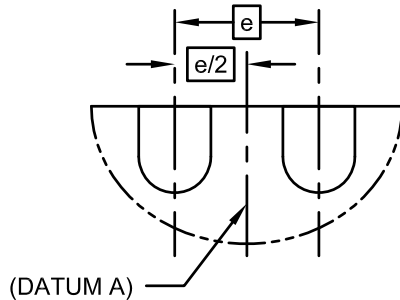

DETAIL B

Dimension Limits	Units	MILLIMETERS		
		MIN	NOM	MAX
Number of Pins	N	8		
Pitch	e	0.50 BSC		
Overall Height	A	0.80	0.90	1.00
Standoff	A1	0.00	0.02	0.05
Terminal Thickness (REF)	(A3)	0.20 (REF)		
Overall Width	D	2.00 BSC		
Exposed Pad Width	D2	1.55	1.70	1.80
Overall Length	E	2.00 BSC		
Exposed Pad Length	E2	0.75	0.90	1.00
Terminal Width	b	0.18	0.25	0.30
Terminal Length	L	0.20	0.30	0.40
Terminal-to-Exposed Pad	K	0.20	-	-

Notes:

- Pin 1 visual index feature may vary, but must be located within the hatched area.
- Package may have one or more exposed tie bars at ends.
- Package is saw singulated
- Dimensioning and tolerancing per ASME Y14.5M.
 - BSC: Basic Dimension. Theoretically exact value shown without tolerances.
 - REF: Reference Dimension, usually without tolerance, for information purposes only.

Microchip Technology Drawing C04-198A Sheet 2 of 2

MCP1710

8-Lead Plastic Very Thin Flat, No Lead Package (LZ) - 2x2 mm Body [VDFN] With 0.55mm Contact Length

Note: For the most current package drawings, please see the Microchip Packaging Specification located at <http://www.microchip.com/packaging>

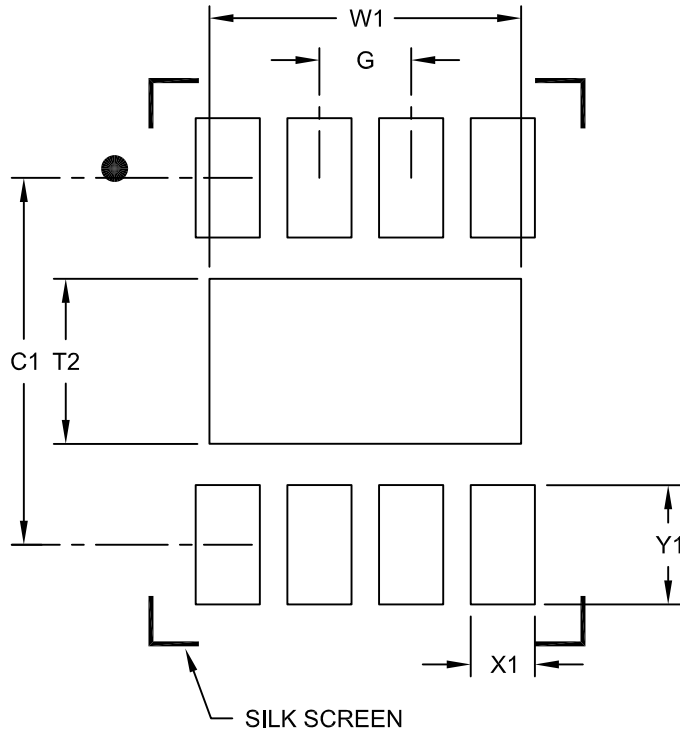

RECOMMENDED LAND PATTERN

Dimension Limits	Units	MILLIMETERS		
		MIN	NOM	MAX
Contact Pitch	E	0.50 BSC		
Optional Center Pad Width	W1			1.70
Optional Center Pad Length	T2			0.90
Contact Pad Spacing	C1		2.00	
Contact Pad Width (X28)	X1			0.35
Contact Pad Length (X28)	Y1			0.65
Distance Between Pads	G	0.15		

Notes:

1. Dimensioning and tolerancing per ASME Y14.5M

BSC: Basic Dimension. Theoretically exact value shown without tolerances.

Microchip Technology Drawing No. C04-2198A

APPENDIX A: REVISION HISTORY

Revision B (November 2012)

- Updated the performance curves for Dynamic Load Step, Dynamic Line Step, Startup From V_{IN} , and Startup From SHDN ([Figure 2-13](#) — [Figure 2-24](#)).

Revision A (September 2012)

- Original Release of this Document.

MCP1710

NOTES:

PRODUCT IDENTIFICATION SYSTEM

To order or obtain information, e.g., on pricing or delivery, refer to the factory or the listed sales office.

<u>PART NO.</u>	<u>I</u>	<u>-XX</u>	<u>X/</u>	<u>XX</u>	Examples:
Device	Tape and Reel	Output Voltage	Temp.	Package	
Device:	MCP1710T: 200 mA Low Dropout Regulator Tape and Reel				a) MCP1710T-12I/LZ: Tape and Reel, 1.2V Output Voltage, Industrial Temp., 8-LD VDFN package
Output Voltage*:	12 = 1.2V "Standard" 18 = 1.8V "Standard" 25 = 2.5V "Standard" 33 = 3.3V "Standard" 42 = 4.2V "Standard" *Contact factory for other output voltage options				b) MCP1710T-18I/LZ: Tape and Reel, 1.8V Output Voltage, Industrial Temp., 8-LD VDFN package
Temperature:	I = -40°C to +85°C (Industrial)				c) MCP1710T-25I/LZ: Tape and Reel, 2.5V Output Voltage, Industrial Temp., 8-LD VDFN package
Package Type:	LZ = Very Thin Dual Flatpack, No Lead (VDFN), 8-Lead				d) MCP1710T-33I/LZ: Tape and Reel, 3.3V Output Voltage, Industrial Temp., 8-LD VDFN package
					e) MCP1710T-42I/LZ: Tape and Reel, 4.2V Output Voltage, Industrial Temp., 8-LD VDFN package

MCP1710

NOTES:

Note the following details of the code protection feature on Microchip devices:

- Microchip products meet the specification contained in their particular Microchip Data Sheet.
- Microchip believes that its family of products is one of the most secure families of its kind on the market today, when used in the intended manner and under normal conditions.
- There are dishonest and possibly illegal methods used to breach the code protection feature. All of these methods, to our knowledge, require using the Microchip products in a manner outside the operating specifications contained in Microchip's Data Sheets. Most likely, the person doing so is engaged in theft of intellectual property.
- Microchip is willing to work with the customer who is concerned about the integrity of their code.
- Neither Microchip nor any other semiconductor manufacturer can guarantee the security of their code. Code protection does not mean that we are guaranteeing the product as “unbreakable.”

Code protection is constantly evolving. We at Microchip are committed to continuously improving the code protection features of our products. Attempts to break Microchip's code protection feature may be a violation of the Digital Millennium Copyright Act. If such acts allow unauthorized access to your software or other copyrighted work, you may have a right to sue for relief under that Act.

Information contained in this publication regarding device applications and the like is provided only for your convenience and may be superseded by updates. It is your responsibility to ensure that your application meets with your specifications. MICROCHIP MAKES NO REPRESENTATIONS OR WARRANTIES OF ANY KIND WHETHER EXPRESS OR IMPLIED, WRITTEN OR ORAL, STATUTORY OR OTHERWISE, RELATED TO THE INFORMATION, INCLUDING BUT NOT LIMITED TO ITS CONDITION, QUALITY, PERFORMANCE, MERCHANTABILITY OR FITNESS FOR PURPOSE. Microchip disclaims all liability arising from this information and its use. Use of Microchip devices in life support and/or safety applications is entirely at the buyer's risk, and the buyer agrees to defend, indemnify and hold harmless Microchip from any and all damages, claims, suits, or expenses resulting from such use. No licenses are conveyed, implicitly or otherwise, under any Microchip intellectual property rights.

Trademarks

The Microchip name and logo, the Microchip logo, dsPIC, FlashFlex, KEELOQ, KEELOQ logo, MPLAB, PIC, PICmicro, PICSTART, PIC³² logo, rPIC, SST, SST Logo, SuperFlash and UNI/O are registered trademarks of Microchip Technology Incorporated in the U.S.A. and other countries.

FilterLab, Hampshire, HI-TECH C, Linear Active Thermistor, MTP, SEEVAL and The Embedded Control Solutions Company are registered trademarks of Microchip Technology Incorporated in the U.S.A.

Silicon Storage Technology is a registered trademark of Microchip Technology Inc. in other countries.

Analog-for-the-Digital Age, Application Maestro, BodyCom, chipKIT, chipKIT logo, CodeGuard, dsPICDEM, dsPICDEM.net, dsPICworks, dsSPEAK, ECAN, ECONOMONITOR, FanSense, HI-TIDE, In-Circuit Serial Programming, ICSP, Mindi, MiWi, MPASM, MPF, MPLAB Certified logo, MPLIB, MPLINK, mTouch, Omniclient Code Generation, PICC, PICC-18, PICDEM, PICDEM.net, PICkit, PICtail, REAL ICE, rLAB, Select Mode, SQI, Serial Quad I/O, Total Endurance, TSHARC, UniWinDriver, WiperLock, ZENA and Z-Scale are trademarks of Microchip Technology Incorporated in the U.S.A. and other countries.

SQTP is a service mark of Microchip Technology Incorporated in the U.S.A.

GestIC and ULPP are registered trademarks of Microchip Technology Germany II GmbH & Co. & KG, a subsidiary of Microchip Technology Inc., in other countries.

All other trademarks mentioned herein are property of their respective companies.

© 2012, Microchip Technology Incorporated, Printed in the U.S.A., All Rights Reserved.

 Printed on recycled paper.

ISBN: 978-1-62076-654-5

QUALITY MANAGEMENT SYSTEM
CERTIFIED BY DNV
== ISO/TS 16949 ==

Microchip received ISO/TS-16949:2009 certification for its worldwide headquarters, design and wafer fabrication facilities in Chandler and Tempe, Arizona; Gresham, Oregon and design centers in California and India. The Company's quality system processes and procedures are for its PIC[®] MCUs and dsPIC[®] DSCs, KEELOQ[®] code hopping devices, Serial EEPROMs, microperipherals, nonvolatile memory and analog products. In addition, Microchip's quality system for the design and manufacture of development systems is ISO 9001:2000 certified.



MICROCHIP

Worldwide Sales and Service

AMERICAS

Corporate Office
2355 West Chandler Blvd.
Chandler, AZ 85224-6199
Tel: 480-792-7200
Fax: 480-792-7277
Technical Support:
<http://www.microchip.com/support>
Web Address:
www.microchip.com

Atlanta
Duluth, GA
Tel: 678-957-9614
Fax: 678-957-1455

Boston
Westborough, MA
Tel: 774-760-0087
Fax: 774-760-0088

Chicago
Itasca, IL
Tel: 630-285-0071
Fax: 630-285-0075

Cleveland
Independence, OH
Tel: 216-447-0464
Fax: 216-447-0643

Dallas
Addison, TX
Tel: 972-818-7423
Fax: 972-818-2924

Detroit
Farmington Hills, MI
Tel: 248-538-2250
Fax: 248-538-2260

Indianapolis
Noblesville, IN
Tel: 317-773-8323
Fax: 317-773-5453

Los Angeles
Mission Viejo, CA
Tel: 949-462-9523
Fax: 949-462-9608

Santa Clara
Santa Clara, CA
Tel: 408-961-6444
Fax: 408-961-6445

Toronto
Mississauga, Ontario,
Canada
Tel: 905-673-0699
Fax: 905-673-6509

ASIA/PACIFIC

Asia Pacific Office
Suites 3707-14, 37th Floor
Tower 6, The Gateway
Harbour City, Kowloon
Hong Kong
Tel: 852-2401-1200
Fax: 852-2401-3431

Australia - Sydney
Tel: 61-2-9868-6733
Fax: 61-2-9868-6755

China - Beijing
Tel: 86-10-8569-7000
Fax: 86-10-8528-2104

China - Chengdu
Tel: 86-28-8665-5511
Fax: 86-28-8665-7889

China - Chongqing
Tel: 86-23-8980-9588
Fax: 86-23-8980-9500

China - Hangzhou
Tel: 86-571-2819-3187
Fax: 86-571-2819-3189

China - Hong Kong SAR
Tel: 852-2401-1200
Fax: 852-2401-3431

China - Nanjing
Tel: 86-25-8473-2460
Fax: 86-25-8473-2470

China - Qingdao
Tel: 86-532-8502-7355
Fax: 86-532-8502-7205

China - Shanghai
Tel: 86-21-5407-5533
Fax: 86-21-5407-5066

China - Shenyang
Tel: 86-24-2334-2829
Fax: 86-24-2334-2393

China - Shenzhen
Tel: 86-755-8203-2660
Fax: 86-755-8203-1760

China - Wuhan
Tel: 86-27-5980-5300
Fax: 86-27-5980-5118

China - Xian
Tel: 86-29-8833-7252
Fax: 86-29-8833-7256

China - Xiamen
Tel: 86-592-2388138
Fax: 86-592-2388130

China - Zhuhai
Tel: 86-756-3210040
Fax: 86-756-3210049

ASIA/PACIFIC

India - Bangalore
Tel: 91-80-3090-4444
Fax: 91-80-3090-4123

India - New Delhi
Tel: 91-11-4160-8631
Fax: 91-11-4160-8632

India - Pune
Tel: 91-20-2566-1512
Fax: 91-20-2566-1513

Japan - Osaka
Tel: 81-66-152-7160
Fax: 81-66-152-9310

Japan - Yokohama
Tel: 81-45-471-6166
Fax: 81-45-471-6122

Korea - Daegu
Tel: 82-53-744-4301
Fax: 82-53-744-4302

Korea - Seoul
Tel: 82-2-554-7200
Fax: 82-2-558-5932 or
82-2-558-5934

Malaysia - Kuala Lumpur
Tel: 60-3-6201-9857
Fax: 60-3-6201-9859

Malaysia - Penang
Tel: 60-4-227-8870
Fax: 60-4-227-4068

Philippines - Manila
Tel: 63-2-634-9065
Fax: 63-2-634-9069

Singapore
Tel: 65-6334-8870
Fax: 65-6334-8850

Taiwan - Hsin Chu
Tel: 886-3-5778-366
Fax: 886-3-5770-955

Taiwan - Kaohsiung
Tel: 886-7-213-7828
Fax: 886-7-330-9305

Taiwan - Taipei
Tel: 886-2-2508-8600
Fax: 886-2-2508-0102

Thailand - Bangkok
Tel: 66-2-694-1351
Fax: 66-2-694-1350

EUROPE

Austria - Wels
Tel: 43-7242-2244-39
Fax: 43-7242-2244-393

Denmark - Copenhagen
Tel: 45-4450-2828
Fax: 45-4485-2829

France - Paris
Tel: 33-1-69-53-63-20
Fax: 33-1-69-30-90-79

Germany - Munich
Tel: 49-89-627-144-0
Fax: 49-89-627-144-44

Italy - Milan
Tel: 39-0331-742611
Fax: 39-0331-466781

Netherlands - Drunen
Tel: 31-416-690399
Fax: 31-416-690340

Spain - Madrid
Tel: 34-91-708-08-90
Fax: 34-91-708-08-91

UK - Wokingham
Tel: 44-118-921-5869
Fax: 44-118-921-5820

10/26/12